



LIGITEK

LIGITEK ELECTRONICS CO.,LTD.  
Property of Ligitek Only

---

**SUPER BRIGHT ROUND TYPE LED LAMPS**

**LVY3332**

**DATA SHEET**

DOC. NO : QW0905-LVY3332

REV. : A

DATE : 18 - Oct - 2005



### Package Dimensions

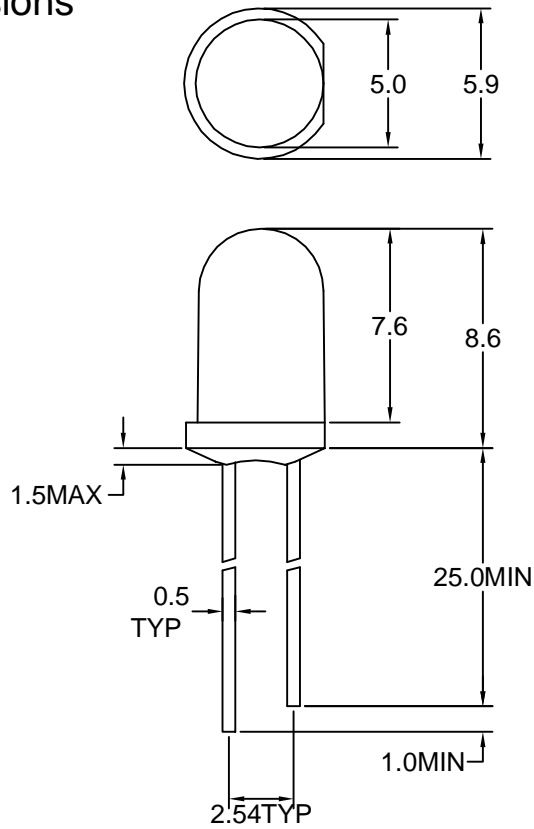

Note : 1.All dimension are in millimeter tolerance is  $\pm 0.25\text{mm}$  unless otherwise noted.  
2.Specifications are subject to change without notice.

### Directivity Radiation

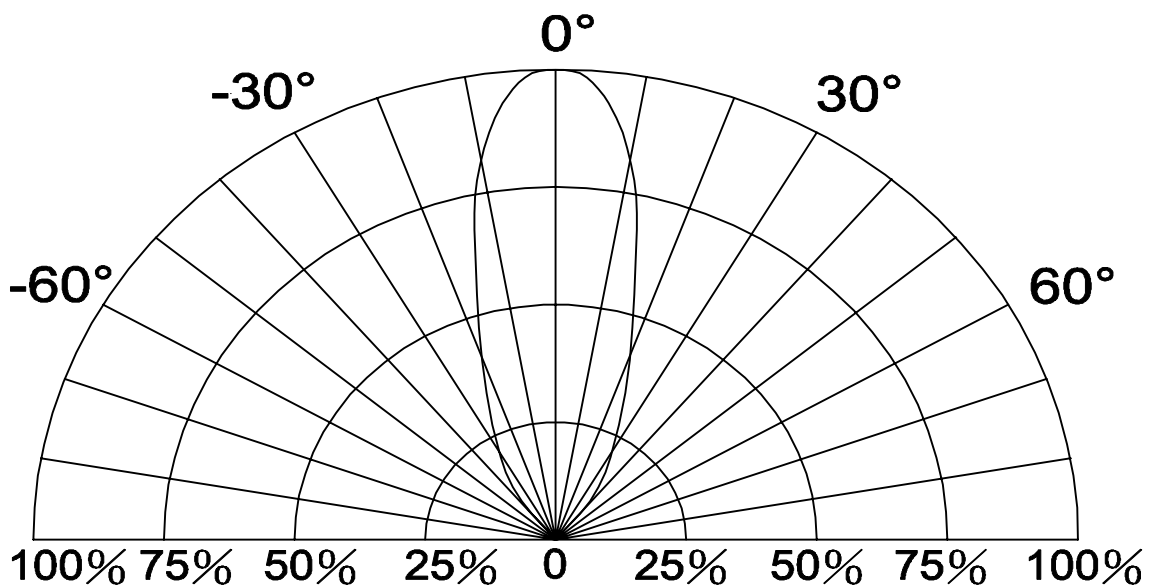

**Absolute Maximum Ratings at Ta=25**

Parameter	Symbol	Ratings	UNIT
		VY	
Forward Current	IF	30	mA
Peak Forward Current Duty 1/10@10KHz	IFP	60	mA
Power Dissipation	PD	75	mW
Reverse Current @5V	Ir	10	μA
Electrostatic Discharge	Esd	2000	V
Operating Temperature	Topr	-40 ~ +85	
Storage Temperature	Tstg	-40 ~ +100	
Soldering Temperature	Tsol	Max 260 for 5 sec Max (2mm from body)	

**Typical Electrical & Optical Characteristics (Ta=25 )**

PART NO	MATERIAL	COLOR		Dominant wave length Dnm	Spectral halfwidth nm	Forward voltage @20mA(V)		Luminous intensity @20mA(mcd)		Viewing angle 2 1/2 (deg)
		Emitted	Lens			Min.	Max.	Min.	Typ.	
LVY3332	AlGaInP	Yellow	White Diffused	590	20	1.7	2.6	300	450	36

Note : 1. The forward voltage data did not including  $\pm 0.1V$  testing tolerance.  
 2. The luminous intensity data did not including  $\pm 15\%$  testing tolerance.



### Typical Electro-Optical Characteristics Curve

#### VY CHIP

Fig.1 Forward current vs. Forward Voltage

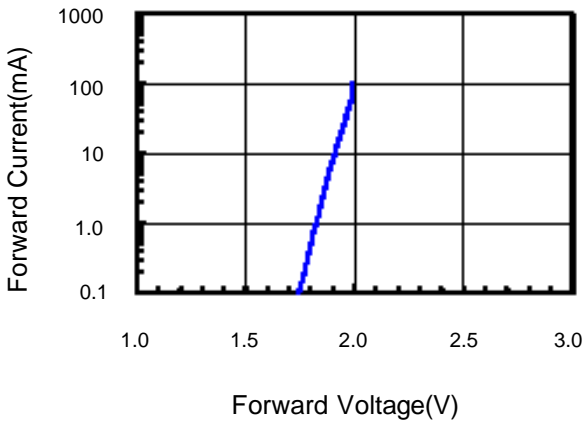

Fig.2 Relative Intensity vs. Forward Current

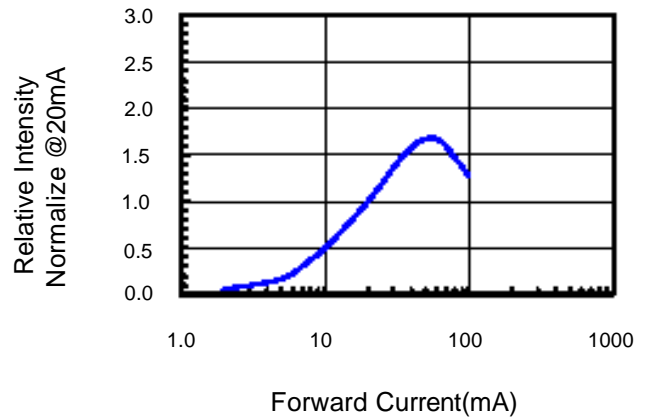

Fig.3 Forward Voltage vs. Temperature

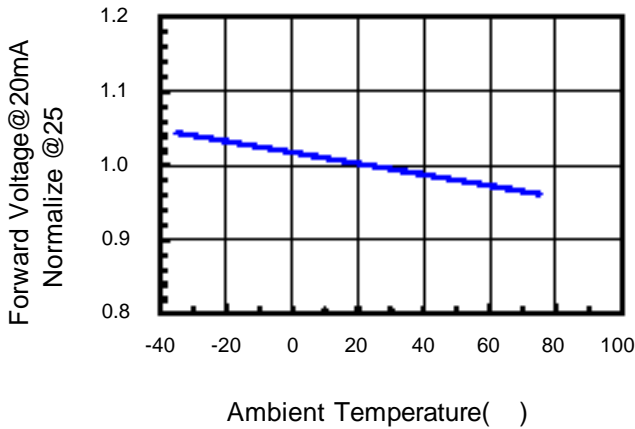

Fig.4 Relative Intensity vs. Temperature

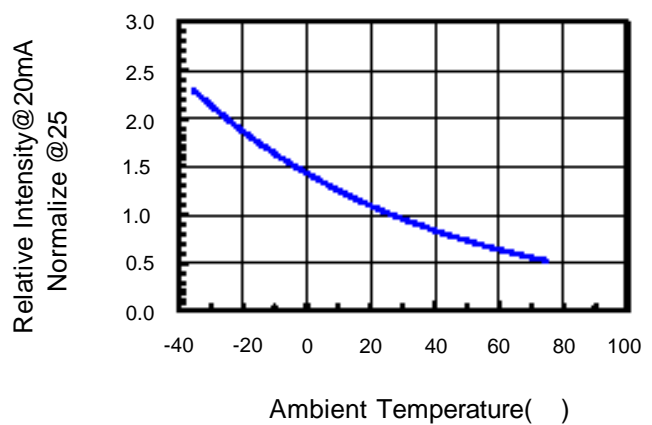
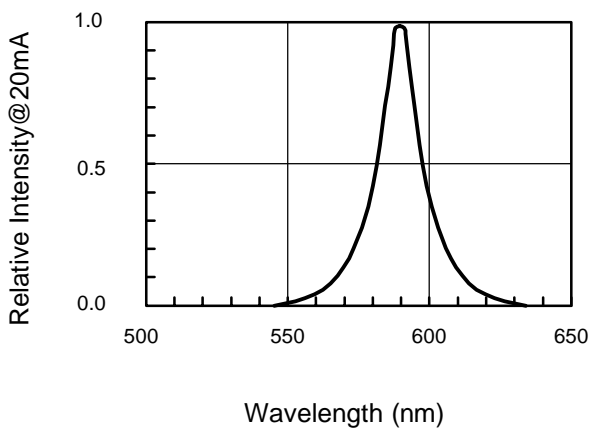

Fig.5 Relative Intensity vs. Wavelength





Reliability Test:

Test Item	Test Condition	Description	Reference Standard
Operating Life Test	1.Under Room Temperature 2.If=20mA 3.t=1000 hrs (-24hrs, +72hrs)	This test is conducted for the purpose of detemining the resisance of a part in electrical and themal stressed.	MIL-STD-750: 1026 MIL-STD-883: 1005 JIS C 7021: B-1
High Temperature Storage Test	1.Ta=105 ±5 2.t=1000 hrs (-24hrs, +72hrs)	The purpose of this is the resistance of the device which is laid under ondition of high temperature for hours.	MIL-STD-883:1008 JIS C 7021: B-10
Low Temperature Storage Test	1.Ta=-40 ±5 2.t=1000 hrs (-24hrs, +72hrs)	The purpose of this is the resistance of the device which is laid under condition of low temperature for hours.	JIS C 7021: B-12
High Temperature High Humidity Test	1.Ta=65 ±5 2.RH=90 %-95% 3.t=240hrs ±2hrs	The purpose of this test is the resistance of the device under tropical for hous.	MIL-STD-202:103B JIS C 7021: B-11
Thermal Shock Test	1.Ta=105 ±5 & -40 ±5 (10min) (10min) 2.total 10 cycles	The purpose of this is the resistance of the device to sudden extreme changes in high and low temperature.	MIL-STD-202: 107D MIL-STD-750: 1051 MIL-STD-883: 1011
Solder Resistance Test	1.T.Sol=260 ±5 2.Dwell time= 10 ±1sec.	This test intended to determine the thermal characteristic resistance of the device to sudden exposures at extreme changes in temperature when soldering the lead wire.	MIL-STD-202: 210A MIL-STD-750: 2031 JIS C 7021: A-1
Solderability Test	1.T.Sol=230 ±5 2.Dwell time=5 ±1sec	This test intended to see soldering well performed or not.	MIL-STD-202: 208D MIL-STD-750: 2026 MIL-STD-883: 2003 JIS C 7021: A-2